

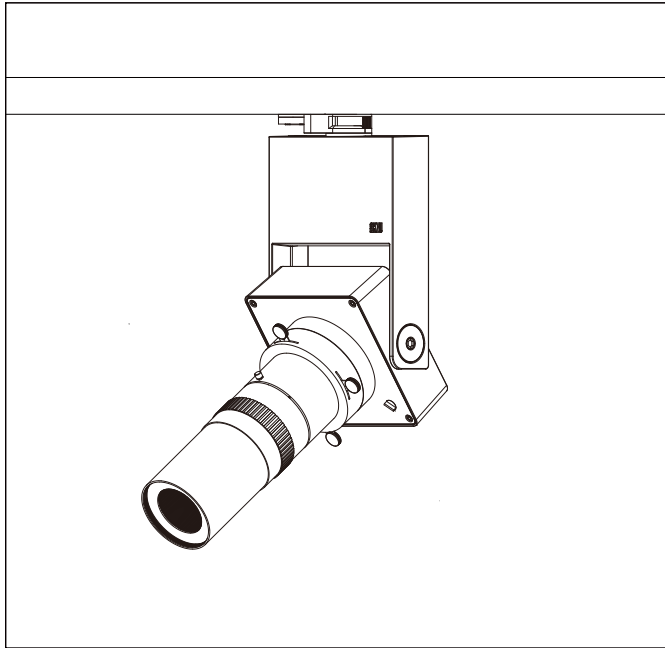

DUX A5 Framing Projector

Product Data Sheet

665284.000



Technical Data

Light source: LED
 Wattage: 28W
 Voltage: 220-240VAC
 Nominal luminous flux: 3200lm
 Beam angle: max 18°
 Color temperature: 4000K, neutral white
 Color Rendering Index: 85
 SDCM: Neutral White

Technical Characteristics

Protection degree: IP20 (EN60598)
 Insulation class: Class I (EN60598)

Production Description

Housing and bracket: cast aluminium, powder-coated, black. 0°- 90° tilt.
 Bracket rotatable through 360° on 3-circuit adapter.
 3-circuit adapter: plastic.
 Including electronic control, dimmable with potentiometer for brightness control 0-100%.
 Replaceable LED module: chip on board.
 Weight: 1.70kg

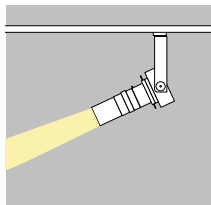

Dimension

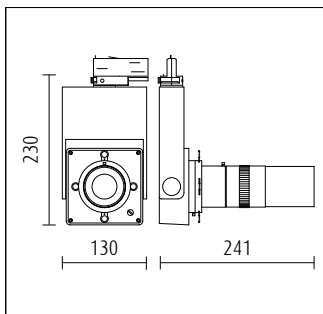

Lighting Distribution Planning Data

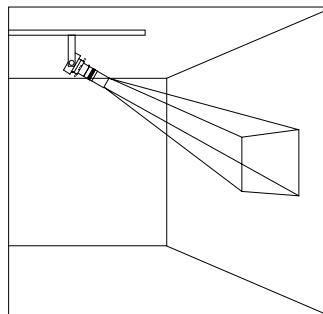

H(m)	D(m)	E(lx)
2	0.45	1395
3	0.68	620
4	1.89	348
5	1.17	223
6	1.34	155

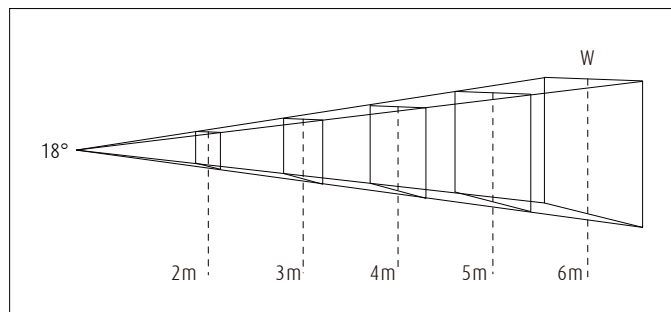

All data, images, and specifications are for reference only and may be changed due to product improvement without prior notice.

More details at www.akzu.com/665284

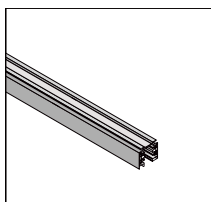

3 circuit track

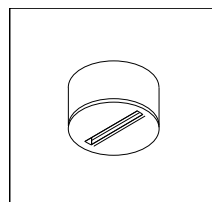

Surface mounted universal mono track point

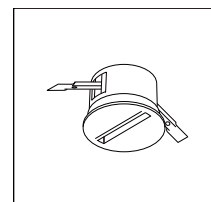

Recessed mounted universal mono track point